

# Granule Gastro®

User Manual



**GRANULDISK®**

Art. no EN16235

Granuldisk AB retains the right to make technical changes to the products.

No responsibility is taken for any printing errors.

[www.granuldisk.com](http://www.granuldisk.com)

Tel. +46 40 671 50 60



---

# Contents

---

EC DECLARATION OF CONFORMITY FOR MACHINERY	5
1 General Description and Safety	7
1.1 To the user	7
1.2 Safety regulations	8
1.3 Technical data	10
1.4 PowerGranules® and PowerGranules BIO®	13
1.5 SIMpel™— easy access to information	14
2 Operating	17
2.1 Start up procedure	17
2.2 Loading wash ware	21
2.3 Control panel	26
2.4 Start and operation	27
2.5 Language selection	30
2.6 Set date and time	31
3 Daily cleaning	33
3.1 Collecting and cleaning of PowerGranules	33
3.2 Cleaning inside the machine	35
3.3 Over night and at longer stoppages	38
3.4 GD Memo™	39
4 HACCP Hygiene and Operation Documentation	41
4.1 General	41
4.2 Reading the data through the control panel	42
4.3 Accumulated values for electricity and water consumption	43
4.4 Download of operation data from USB Port	44
5 Trouble shooting and alerts	45
5.1 User related notices	45
5.2 Error codes	47
6 Notes	51



---

# EC DECLARATION OF CONFORMITY FOR MACHINERY

---

Original

Directive 2006/42/EC, Annex II 1A

**Manufacturer (and where appropriate his authorised representative):**

Company: Granuldisk  
Address: Jägershillsgatan 13, 213 75 Malmö

**Hereby declares that**

Type of machinery: Granule pot washing machine for  
commercial kitchens  
No. of machinery: Granule Gastro®

**Complies with the requirements of Machinery Directive 2006/42/EC.**

**Complies with the applicable requirements of the following EC  
directives:**

2014/30/EU, EMC

2011/65/EU, WEEE

2012/19/EU, RoHS

**The following harmonized standards have been applied:**

EN 60204-1:2018

SS-EN 60335-1:2012

SS-EN 60335-2-58:2019

SS-EN 55014-1:2017

SS-EN IEC 61000-6-1:2019

SS-EN IEC 61000-6-2:2019

SS-EN 61000-6-3:2007

IEC 61000-6-3:2006/AMD1:2010

**The following other standards and specifications have been applied:**

SS-EN 1717:2000

SS-EN 13077:2018

**Authorized to compile the technical file:**

Name: Staffan Stegmark  
Address: Jägershillsgatan 13, 213 75 Malmö

**Signature:**

Place and date: Malmö, 26.04.2021  
Signature:



Name: Mikael Samuelsson  
Position: CEO



---

# 1 General Description and Safety

---

## 1.1 To the user

Granule Gastro is a Granule pot washing machine – a pot washing machine for commercial kitchens that is designed for washing pots and pans.

This manual is your guide for the correct use of the Granule Gastro® pot washing machine.

Granuldisk recommends that you study the manual thoroughly to be sure that the machine is installed and used correctly and safely.

Ensure that the manual is always available during the whole lifetime of the machine.

Granuldisk accepts no responsibility for damage to the equipment or other damage or injury caused by not following the directions in this manual.

User manual in original.

## 1.2 Safety regulations



### **NOTE**

*Read the safety notes and operating instructions in this manual carefully. Keep the operating instructions for future reference. Granuldisk does not assume liability or warranty in case of non-adherence to these safety and operating instructions.*

*Do not make changes, additions or reconstructions in the pot washer without the approval of the manufacturer. Use the pot washer only after you have read and understood the user manual. Allow Granuldisk to provide information about the operation and functioning of the pot washer.*

*Always operate the machine as described in these operating instructions. Train the operating personnel about handling of the machine and inform them about the safety notes. Repeat the training sessions at regular intervals to prevent accidents.*

For your safety, test the local fault current circuit breaker (FI) regularly by pressing the test button.

Close the on-site water shut-off valve after the work is complete. Switch off the local mains disconnecter after the work is complete.

The composite material in the granules is approved for use in conjunction with food.



### **WARNING**

*The machine uses hot water. Avoid contact with the skin as there is a scalding risk!*



### **WARNING**

*There is a risk of slipping if granules are left on the floor.*



### **WARNING**

*Formaldehyde, which is dangerous if inhaled, may be formed if the original granules made of POM plastics, catch fire. Does not apply for the PowerGranules BIO.*



**WARNING**

*Always lock the hood in its upper position with the safety pin when daily cleaning is carried out.*

*Do not place any items on top of the hood. There is no stop of upward motion. If items block the hood the equipment could get damaged.*

**NOTE**

*Regarding the handling and use of detergent and rinse aid with the product, please see the chemical manufacturer's instructions. Use high quality products for best wash result. Also refer to information about detergent and rinse aid in the Service manual.*

## 1.3 Technical data

### GENERAL

Design	Hood-type pot washer Round rotating stainless steel basket
External dimensions	2339 (± 25) x 850 x 1002 mm H x W x D (open)
Weight	403 kg (filled machine) 310 kg (empty machine)
Tank volume	83 liter
Loading volume	220 litres (Ø 700 mm x 570 mm)
Rinse water volume	4 litres (ECO program) 8 litres (Short/Normal program) To achieve 3600 HUE according to NSF/ANSI 3 hygiene guidelines, 8 litres is necessary.
Granule amount	8 litres
Wash water temperature	65 °C
Rinse water temperature	85 °C
Sound pressure level	< 70 dB (A)

### PROGRAMS & CAPACITY

Wash programs with granules	Eco: 2 min, 10 sec
	Short: 3 min, 20 sec (+30 sec with steam reduction)
	Normal 5 min, 20 sec (+30 sec with steam reduction)
Wash programs without granules	Eco: 2 min, 10 sec
	Short: 2 min, 40 sec (+30 sec with steam reduction)
	Normal: 4 min, 40 sec (+30 sec with steam reduction)
Max. / normal capacity per hour mode (normal capacity incl. handling)	144/114 GN 1/1 or similar in other pots

---

Capacity per program	6 GN 1/1 65 mm depth or 3 GN 1/1 up to 200 mm depth and 3 GN 1/1 up to 65 mm depth, or similar in other pots
----------------------	--

---

**ELECTRICAL CONNECTION**

Voltage**	3~ 400-415V/50 Hz + PE 3~ 230V/50 Hz + PE 3~ 380V/50 Hz + PE
Fuse (at output 11.9 kW)	25A (380, 400V, 415V) 40A (230V)
Fuse (at output 16.9 kW)	32A (400V-415V, 380V)
Frequency	50 Hz
Maximum output	11,9 kW (hot fill) 16,9 kW (cold fill)
Wash pump motor	2.6 kW
Rinse pump motor	0,37 kW
Heater wash tank*	9 kW at output 11,9 kW 14 kW at output 16,9 kW
Heater rinse tank*	9 kW at output 11,9 kW 14 kW at output 16,9 kW
Enclosure rating	IPX5

---

**WATER CONNECTION**

Hardness/Connection	Total hardness: 3-7 °dH, 5-12 °TH, 53-125 PPM  ¾" BSP male (DN20)
Connection A	11.9 kW unit: 1-6 bar, 15 l/min, 55-65 °C (hot fill)  16.9 kW unit: 1-6 bar, 15 l/min, 5-65 °C (hot or cold fill)  NB! Reverse osmosis water and totally softened water must not be used.

Connection B	11.9/16,9 kW unit: 1-6 bar, 15 l/min, < 20 °C (3-6 bar 15 l/min, when steam reduction option is fitted) < 20°C
--------------	---

---

### VENTILATION & DRAIN

Ventilation with steam reduction	150 m <sup>3</sup> /h
Ventilation without steam reduction	400 m <sup>3</sup> /h
Heat emitted to room with steam reduction (total/sensible/latent)	1.2 kW / 0.4 kW / 0.8 kW
Heat emitted to room without steam reduction (total/sensible/latent)	1.6 kW / 0.4 kW / 1.2 kW
Drainage pipe	Pipe Ø 32 mm (outer diameter)
Drain	Capacity requirement 50 l/min No drain pump, gravity drain  The machine must not be placed directly over a drain.

---

### DETERGENT & RINSE AID

Detergent and rinse aid	Required. 230 VAC signal is available from separate box  Max load total 0,5 A
-------------------------	---

\* Not in use simultaneously

\*\* For specific data regarding delivered machines, please see machine rating plate



### NOTE

*Granule Gastro® is supplied with a 2 metres long electric cable to be connected to an approved supply disconnecting device on the wall. The supply disconnecting device is not included in the delivery.*

## 1.4 PowerGranules® and PowerGranules BIO®

- PowerGranules and PowerGranules BIO are specially designed to work with Granule pot and pan washing machines from Granuldisk.
- They ensure the best wash result as well as the longest working life both for themselves and the machine.
- The composite material in the PowerGranules is approved for use in conjunction with food.
- The PowerGranules BIO is a biodegradable granule.

### Collection of PowerGranules as part of daily cleaning

- Insert your Granule collector in the machine as per instructions in Daily cleaning section of this manual.
- Choose a "Granule collection program" by pressing "STOP", waiting 3 seconds, then press & hold Granule button and Short program button until the text "Granule collecting program" appears in the display.
- For a spotless clean wash result, check the recommended level (8 litres) of granules every day when collecting the PowerGranules. **Top up with PowerGranules if the level goes under the horizontal level mark.**

See Fig. 23 *Check granule level*

- Do not mix PowerGranules and PowerGranules BIO® in the machine. Technically there will be no harm to the potwasher, however the waste management is different (see below) and therefore we recommend exchanging the whole batch of granules when switching to PowerGranules BIO®.

### Exchange of worn out PowerGranules

- Please follow the recommended exchange of PowerGranules communicated by the GDMemo™ (message occurs every 2 500 Granule cycles). Run a Granule collection program as per above and replace with a new batch.
- After exchanging the granules, reset the reminder by pressing the STOP button, wait for 3 seconds, then press the Granule button 5 times. OK is shown in the display during 2 seconds after the reset.
- Worn out granules should be handled as non-hazardous waste. Used granules should be sealed in a plastic bucket with a lid or in a plastic bag before being disposed of. PowerGranules can be sorted as recyclable plastic or combustible waste. PowerGranules BIO® should be sorted as combustible waste or according to local regulations. PowerGranules BIO® is biodegradable and therefore cannot be recycled as plastic.

## 1.5 SIMpel™— easy access to information

To make it easier for the operator to find information about the machine and how to use it, there is a QR-code on the machine.

The sticker is placed under or at the side of the display.



- 1 Scan the QR code on the sticker.

See Fig. 1 *QR-code on the sticker*

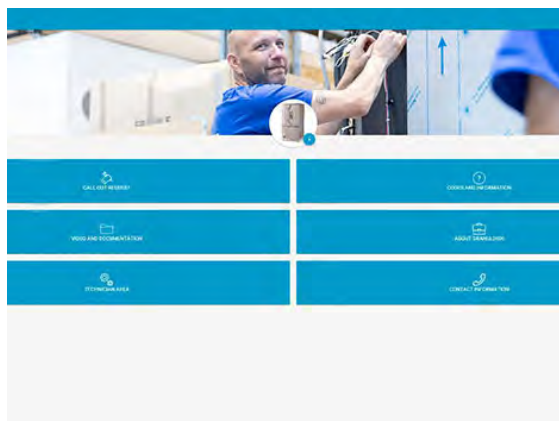

**Fig. 1 QR-code on the sticker**

- 2 When you scan the QR code, you enter the following menu.

(Note that the interface may vary depending on the device used).

See Fig. 2 *Menu*



**Fig. 2 Menu**

3 Select the language in the upper right corner. English is default.

**Explanation of the different boxes:**

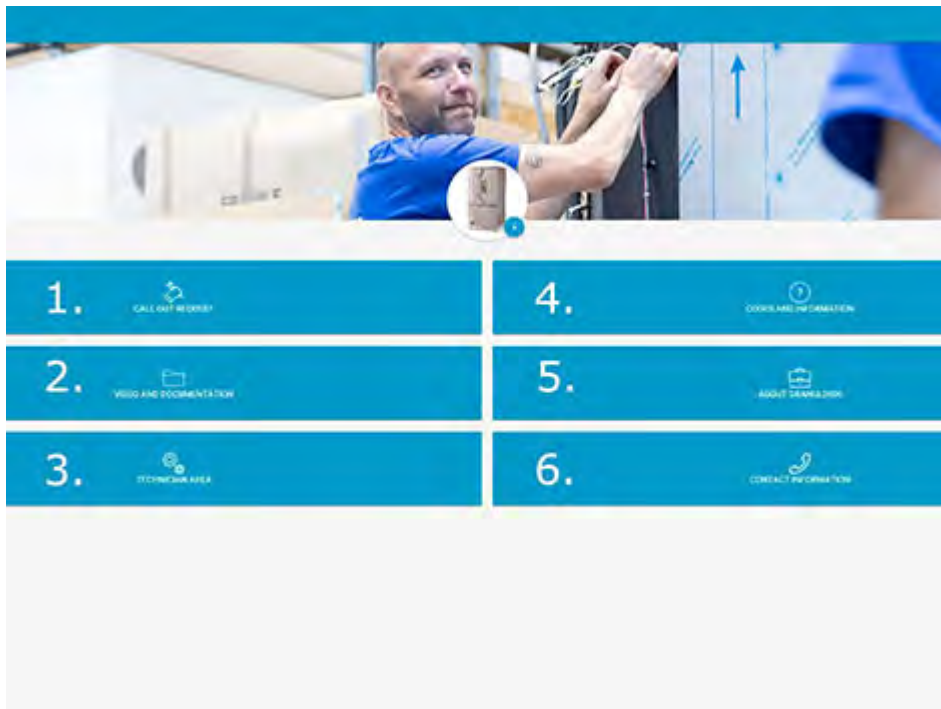

1. CALL OUT REQUEST	Make a service call on the machine
2. VIDEO AND DOCUMENTATION	User manuals and videos of accessories/ daily cleaning
3. TECHNICIAN AREA	Only for technicians/service partners
4. CODES AND INFORMATION	List of error codes
5. ABOUT GRANULDISK	Link to our website
6. CONTACT INFORMATION	Contact information to service partner





---

## 2 Operating

---

### 2.1 Start up procedure

- 1 Place the tank grid in position.

See Fig. 3 *Tank grid*



**Fig. 3 Tank grid**

- 2 Put the basket wheel in place.

Swing it around until it drops down on the pegs in the middle of the wheel.

See Fig. 4 *Basket wheel*



**Fig. 4 Basket wheel**

- 3 Empty the Granule Collector with PowerGranules into the left part of the wash tank.

See Fig. 5 *Granule filling*

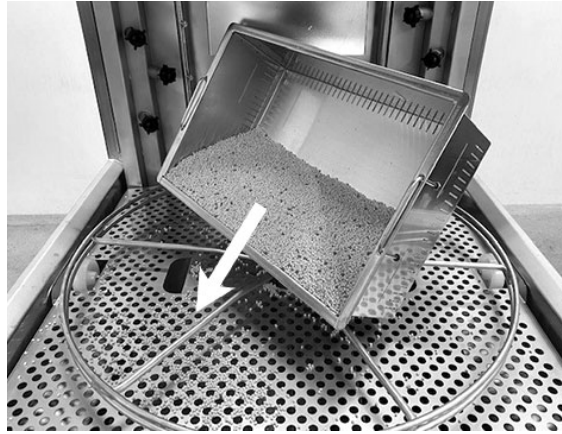

**Fig. 5 Granule filling**

- 4 Close the drain valve on the front of the machine

See Fig. 6 *Drain valve*



**Fig. 6 Drain valve**

- 5 Switch on the main electrical switch.



**NOTE**

*Never place items on top of the hood.*

### Filling with water

- 1 Press the Confirm (1) button in order to fill the wash tank.

Fill wash tank?



- 2 If the hood is in the raised position, it will close automatically before starting the filling.
- 3 The machine will now fill with water and heat up to the correct temperature. On the panel, the diodes for program selection (3-5) flash out of sequence with the diodes for washing with or without granules (6-7) during filling. The following message is displayed:

```
XX °C   XX°C
Filling the wash
tank
```

- 4 Filling and heating takes about 20 minutes (hot water connection, +55 °C). For optional cold water connection (+10 to 12 °C), filling and heating take about 40 minutes. If the correct temperature has not been attained in the wash tank after filling, the following message is displayed:

```
50°C   60°C
Heating the
wash tank, 65°C
```

- 5 Ready to use when the correct temperature has been attained in the wash tank.

A pre-selected program is now displayed;

```
65°C   70°C
Eco program
```

with granules  
wash time: 2:10

### Preparing utensils

- 1 Empty and scrape off all food remains before loading the utensils

See Fig. 7 *Scrape off food*

- No soaking or scrubbing is needed.
- No usage of hand-soap or similar (to avoid foaming which could lead to extended problems).



**Fig. 7 Scrape off food**

- 2 Pots and pans containing moist protein-rich food remains may need a splash of water before being loaded into the machine.

## 2.2 Loading wash ware

### Loading wash ware

All utensils must be loaded with the inside facing the spray pipes, thus outwards. It is important that all items are firmly in place when being washed.

### Inserting and removing the basket

The basket is loaded on an adjoining table. Press the arrow button to open the hood. Slide the wash basket into the machine. The basket is designed so that you clearly feel when the basket is placed correctly.

Check that nothing is sticking out from the basket's sides or bottom. The downward movement of the hood or basket rotation must not be hindered.

See Fig. 8 *Standard wash basket*

#### Standard wash basket (26426)

Capacity: 6 GN 1/1 65 mm or 3 GN 1/1 up to 200 mm + 3 GN 1/1 up to 65 mm. Equipped with small hooks which enables up to 12 small containers (1/4, 1/6, 1/9) to be loaded directly into the wash basket

See Fig. 8 *Standard wash basket*

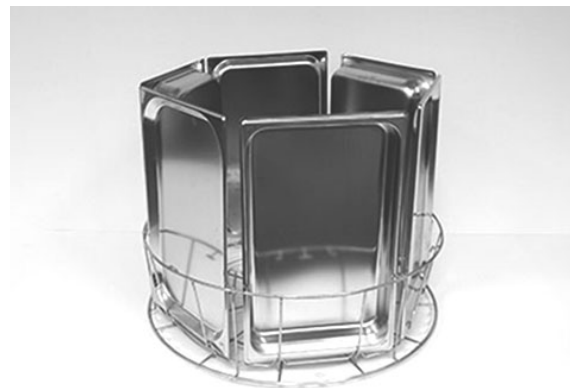
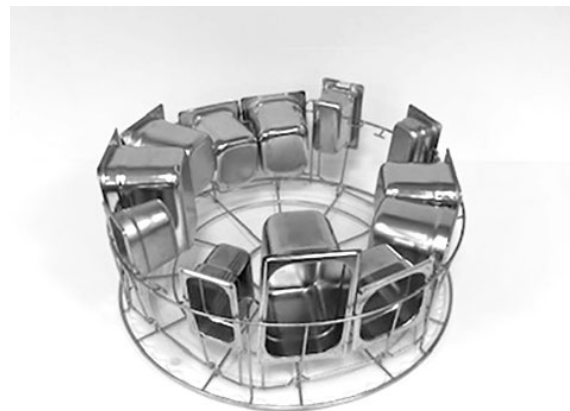

**Fig. 8 Standard wash basket**

Possible to load 6 x GN 1/3

Possible to load 12 x small GN containers. Choose among GN 1/4, GN 1/6, GN 1/9.

See Fig. 9 *Standard wash basket*



**Fig. 9 Standard wash basket**

### Insert for trays (19992)

To be placed inside standard wash basket (26426). Holds 2 GN 2/1 or, 6 baking trays 600x400 mm up to 20 mm edge and 2 GN 1/1 sized trays, up to 16 grids, up to 8 chopping boards and GN 1/1 lids.

See Fig. 10 *Insert for trays with GN 2/1*



**Fig. 10** *Insert for trays with GN 2/1*

Possible to load grids, chopping boards, baking trays, flat trays and GN 1/1 lids.

See Fig. 11 *Insert for trays*



**Fig. 11** *Insert for trays*

### Holder for bowls & pots with integrated ladle holder (13756)

To be placed inside standard wash basket (26426), small pegs in the bottom of the basket hold it in place. Capacity: up to 5-6 bowls or pots. Containers from approx 60 mm to 170 mm deep can be washed.

Possible to load ladles, whisks, spatulas and similar in the net basket in the middle of the holder. Height of ladles up to 500 mm.

See Fig. 12 *Holder for pots and bowls*

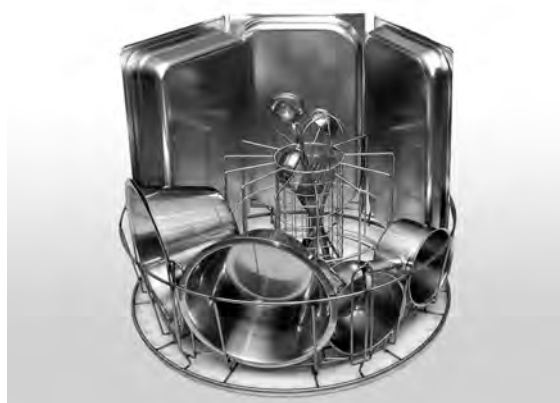
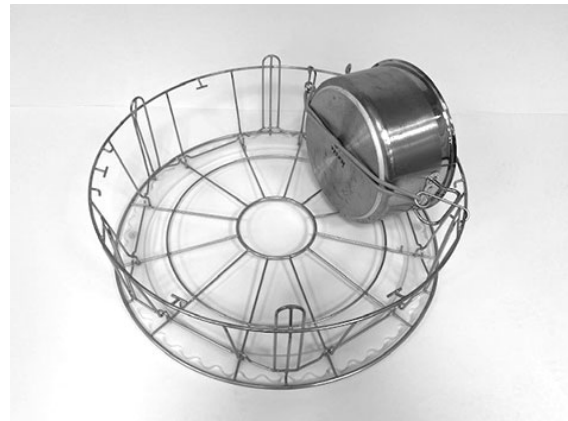

**Fig. 12** *Holder for pots and bowls*

**Flexible pot holder (13789)**

Rubber strap with two hooks. Rubber strap to be placed around pot and hooked on to the basket. Be careful when fastening and releasing the rubber bands as the hooks may cause harm.

See Fig. 13 *Flexible pot holder*

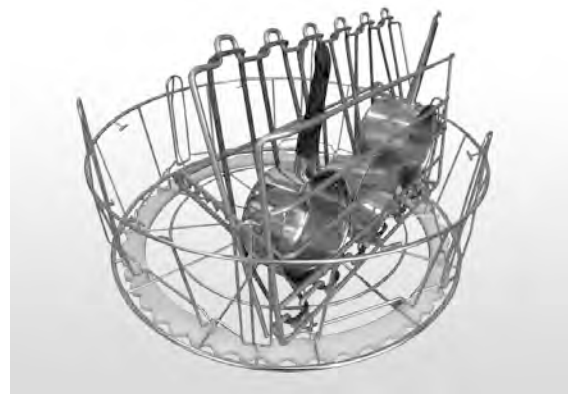

**Fig. 13 Flexible pot holder**

**Multiflex holder for saucepans, small bowls and sieves (20554)**

To be placed inside standard wash basket (26426). Capacity: up to 3-4 saucepans or up to 4-5 small bowls, sieves etc.

See Fig. 14 *Multiflex holder*

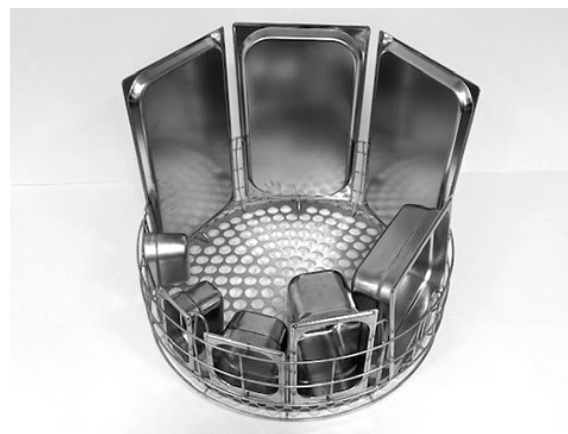

**Fig. 14 Multiflex holder**

**Wash basket with bottom grid (26140)**

Same capacity as the standard wash basket (26426). The bottom grid prevents handles etc from slipping through the bottom of the basket.

See Fig. 15 *Wash basket with bottom grid*



**Fig. 15 Wash basket with bottom grid**

**Pot basket (21423)**

Holds 2 large pots (200 mm) or 1 large pot (400 mm) Placed in machine instead of Standard wash basket.

See Fig. 16 *Pot basket*



**Fig. 16** *Pot basket*

When placing **one** large pot in the pot basket, use one or two Flexible pot holders to fixate the pot.

Hook the rubber band as and wrap it around the pot and hook on to the bar on the other side.

See Fig. 17 *Pot basket*



**Fig. 17** *Pot basket*

**Net basket with lid (21477)**

For ladles, whisks or smaller light items. To place inside the accessory 19992.

See Fig. 18 *Net basket with lid*



**Fig. 18** *Net basket with lid*



**Folding table (19570)**

Can be installed on front or on either side of the machine.

See Fig. 19 *Folding table*



**Fig. 19** *Folding table*

## 2.3 Control panel

- 1 Confirm button is used to answer "yes" to a question shown in the display window

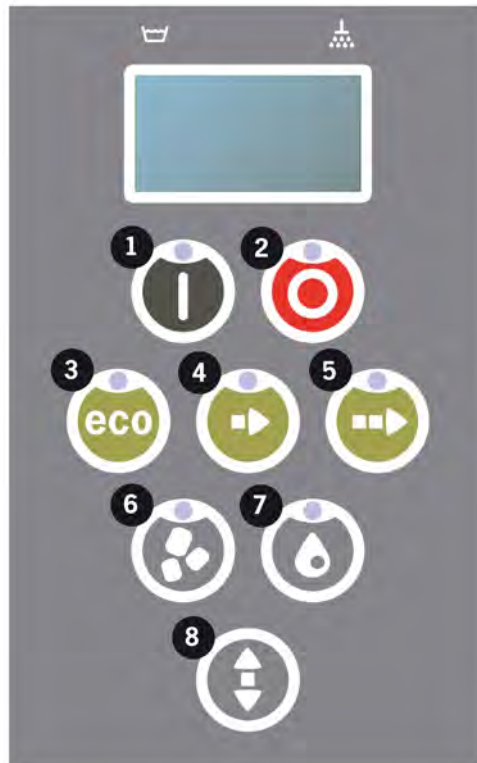

- 2 The Stop button is used to reset potential alarms.

It is also used to enter sleep mode. After 30 seconds the display light goes out and the machine goes into sleep mode. The Stop button's red diode stays lit during sleep mode, but all functions in the machine are deactivated.

Push any button to reactivate the machine.

**In sleep mode there is no heating of the wash tank or rinse tank.**

- 3 Start ECO program
- 4 Start Short program
- 5 Start Normal program
- 6 Washing with granules
- 7 Washing without granules
- 8 Hood up and down

## 2.4 Start and operation

### 1 Press the Confirm button (1)

- If temperature is lower than 65 °C in wash tank at the time of the first start, once the wash tank has been filled, the machine will continue heating.
- Washing at a too low temperature increases the risk of foaming and the items not being hygienically clean.
- Reprogramming may be carried out by authorised personnel only.

62°C (blinking) 59°C  
 Heating the  
 wash tank, 65°C

### 2 Select washing with or without granules (6) or (7). For slightly soiled pans, perforated containers, transparent plastic or teflon containers, choose a program without granules. For normal to heavily soiled pots and pans, choose a powerful Granule cycle to blast the utensils clean.

### 3 Select and start required wash time (3), (4) or (5)

#### **ECO**

2 min, 10 sec (with granules)

2 min, 10 sec (without granules)

#### **Short**

3 min, 20 sec (with granules)

2 min, 40 sec (without granules)

+30 sec with optional steam reduction

#### **Normal**

5 min, 20 sec (with granules)

4 min, 40 sec (without granules)

+30 sec with optional steam reduction

65°C 85°C  
 Eco program  
 with granules  
 Time remaining: 2:10

### 4 Once the wash program is complete, the hood goes up, and the machine goes into stand-by mode and shows the latest program used, e.g.

65°C 85°C  
 Eco program  
 with granules  
 Wash time: 2:10

**WARNING**

*The hood can not be opened until the wash program is complete.*

- 5 Close the hood by pressing button (8) if you are not running another wash program straight away. It saves energy and reduces evaporation from the wash tank.

**Stopping the machine while in operation**

- Switch to washing with water for about 30 seconds in order to rinse off all granules. Then press STOP (2).
- In an emergency: Just press STOP (2).

**NOTE**

*Utensils may have remains of detergent and should be washed again before they are taken out of the machine. Never drain an emergency stopped machine! (granules left in the pump without water will jam the pump impeller.)*

**Resetting of overheat protection**

Reset overheat protection if error codes 104 and 105 occur.

- 1 Empty the wash tank.
- 2 Clean the level sensor.
- 3 Unscrew the black cap.
- 4 Reset the overheat protection using a small screwdriver to stick into the protector and push the reset button. If the protection has tripped, a click is heard when it is reset.

See Fig. 20 Access to over-heat protectors



**Fig. 20 Access to overheat protectors**

- 5 If the error code recurs in the next few hours, contact a service engineer.

**Inspecting the wash ware**

- 1 Examine the pots and pans after each program.
- 2 To make sure no granules are left, turn all washware (containers, pans etc) upside down, before taking the items out of the machine.
- 3 Remove any granules that may be stuck in corners, sharp angles and other inaccessible places

See Fig. 21 *Make sure no granules are stuck*



***Fig. 21 Make sure no granules are stuck***

## 2.5 Language selection

To change the language settings:

- 1 Press the STOP button, release it and wait for 3 seconds.



- 2 Press the (4) "Short program" button, five times.
- 3 The display shows the following:
 

```
Language
< English >
Select Back
```
- 4 Press the Confirm button for "select".
- 5 Scroll using the buttons for ECO(3) or Normal (5) program, to step through the list of languages.
 

```
Language
< English >
OK Cancel
```
- 6 Select a language by pressing the Confirm button (1); OK.
- 7 Press STOP button (2) to quit programming mode.

## 2.6 Set date and time

To change the date and time:

- 1 Press STOP (2), then press Short program button (4) 5 times and 1 time on ECO program button (3).

Change date and time

ddmmyy hh:mm

210101 13:00

Choose Back



- 2 Press Function button (1) to choose and to be able to change date and time.

Change date and time

ddmmyy hh:mm

210101 13:00

OK Cancel

- 3 Adjust date and time by using Normal program button (5) to step to the right. ^^ marks which number can be changed. Use Short program button (4) to change up and Granule button (6) to change down.
- 4 For OK and to save new settings press Function button (1). Use STOP button (2) to quit programming mode without saving.





---

## 3 Daily cleaning

---

### 3.1 Collecting and cleaning of PowerGranules

- 1 Use the Granule Collector



**Fig. 22 Granule collector**

- 2 Place the Granule collector on the basket wheel. It should be placed as tightly as possible to the hood, which means that the Granule collector will be tilting slightly.

See Fig. 22 *Granule collector*

- 3 Close the hood and start the Granule collecting program as described below.

**Granule Collecting program:**

First press the STOP button (2).

Press Short program (4) and Granule program (6) at the same time for 3 seconds.

65°C 70°C  
Granule collect  
program  
Wash time: 5:10



**NOTE**

*No detergent dosing, no heating of wash or rinse tank will occur during the collecting program.*

- 4 Once the Granule collecting program is complete, a message is shown:

- From 2500 to 501 programs: Check granule level (after every 10th collection)
- From 500 to 251 programs: No message (goes back to STOP mode)
- From 250 to 1 program: Order granules (after every collection)
- From 0 program: Change granules now (after every collection until message is reset)

Top up with granules when needed. Wash result will suffer if the granule level is too low.

- 5 When the hood is lifted, the machine will return to STOP mode.
- 6 Take the filled Granule collector out from the machine and rinse the granules thoroughly. Make sure no food residues are left.
- 7 Check that the Granule level reaches up to the horizontal mark in the Granule collector

See Fig. 23 *Check granule level*



**Fig. 23 Check granule level**



**NOTE**

*Not 100% of the granules will be collected. 1–2 deciliters can remain in the tank.*



**NOTE**

*Too many or too few granules will impair wash results. Too many can also cause blocking of the spray nozzles.*



**NOTE**

*Do not use disinfectant or other cleaning products when cleaning the granules. The residue from these products will cause foaming in the machine with poor wash result as a consequence.*

## 3.2 Cleaning inside the machine

- 1 Press STOP button (2) and open drain valve to empty wash tank.

See Fig. 24 *Drain valve*



**Fig. 24 Drain valve**

- 2 Secured the hood in it's upper position.

See Fig. 30 *Hood lock*

- 3 Switch off at the main electrical switch.

- 4 Lift out the basket wheel. Then lift out the tank grid. Clean and flush the parts with water.

See Fig. 25 *Tank grid*

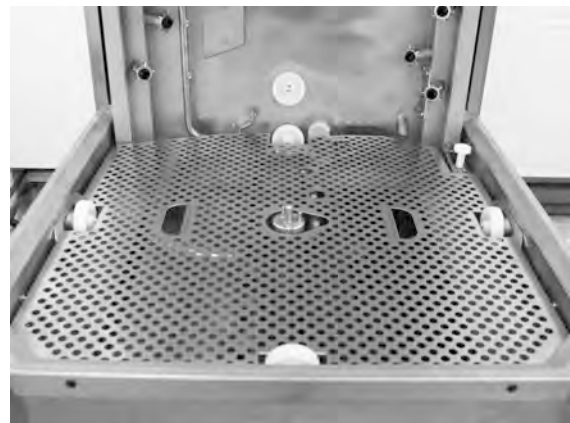

**Fig. 25 Tank grid**

- 5 Flush the inside of the tank with clean water.

- 6 Clean and flush the Granule damper with water.

Clean the perforated surface of the Granule damper to ensure that there are no granules left there.

See Fig. 26 *Granule damper*

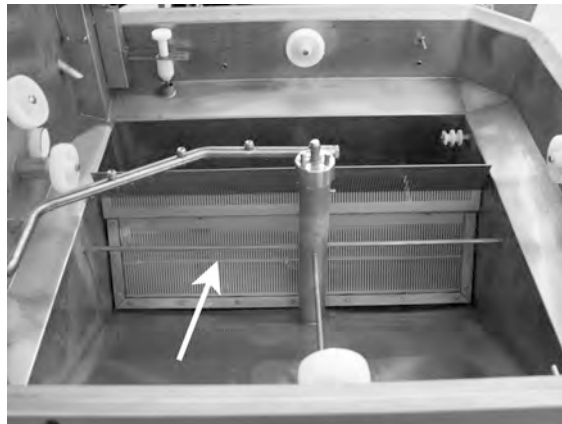

**Fig. 26 Granule damper**

- 7 Check that the sealing strip for the Granule damper is undamaged.
- 8 Check and clean the wash nozzles. If necessary unscrew the outer ring to remove if there are blockages.
- 9 Clean and flush the bottom sieve (A) with water. Make sure there are no food residues on the sieve.

See Fig. 27 *Bottom sieve and level sensor*

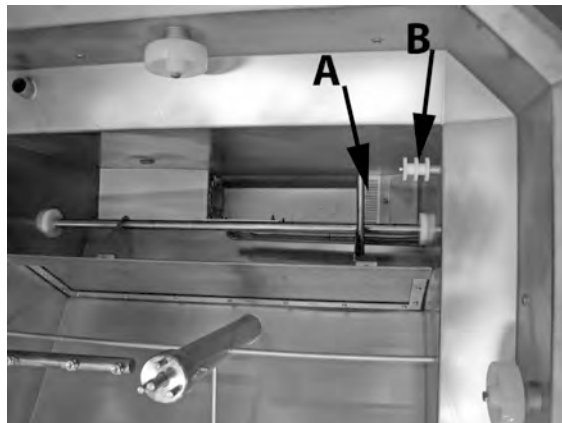

**Fig. 27 Bottom sieve and level sensor**

- 10 Wipe off level sensor (B).

See Fig. 27 *Bottom sieve and level sensor*

- 11 Wipe grease of hood seals.

- 12 Check that the rollers supporting the basket wheel rotate freely.

- 13 Check the operation of the overflow tap. Clean if required.

See Fig. 28 *Overflow tap*



**Fig. 28 Overflow tap**

- 14 The top should be wiped off when required or at least once a month.

- 15 For video instructions use the QR code and watch the daily cleaning on Youtube

See Fig. 29 *QR code*



**Fig. 29 QR code**



**NOTE**

*The outside of the machine should **not** be washed with high-pressure water.*

**Replacement of cleaned items**

- Put back bottom sieve if it has been unscrewed.
- Put back tank grid
- Put back basket wheel

---

### 3.3 Over night and at longer stoppages

- Ensure that wash tank is empty after cleaning.
- Raise hood to its highest position and prevent it from descending with the peg provided
- Leave peg there as long as the machine is shut down.

See Fig. 30 *Hood lock*

- PowergGranules should be stored in Granule collector standing in the machine.
- At longer stoppages, any water remaining at the bottom of the tank should be removed with a sponge or similar absorbent
- After a long stoppage, check operation of the machine according to service manual, possibly with the assistance of a service engineer.



**Fig. 30 Hood lock**

## 3.4 GD Memo™

GD Memo is an integrated function which informs the user of the machine's most important maintenance requirements. With GD Memo, it is possible to ensure optimum wash results, avoid breakdowns during peak hours and maintain the lowest possible operating costs. This function is integrated in the control panel and keeps the user informed as follows:



### 1. Time to change wash water

—to ensure a good washing result. The “Washing without granules” button [7] flashes and the message “Change water” is shown in the display. This information disappears automatically once the water has been changed or can be reset by pressing Stop button [2], releasing it, waiting 3 seconds and then pressing button [7] five times. OK is shown in the display during 2 seconds after the reset. This reminder appears after every 30 wash cycles in preset. The number of washes may be varied between 15 and 40 washes.

### 2. Time to change granules

— to maintain the wash power in the machine. The “Washing with granules” button [6] flashes and the message “Change granules Now! See instruction on container” is shown in the display. After changing the granules, reset the reminder by pressing the STOP button [2], wait for 3 seconds, then press the Granule button [6] 5 times. OK is shown in the display during 2 seconds after the reset. A Granule change reminder appears after every 2500 wash cycles. The alarm reset procedure is also written on the Granule container for easy access to the instruction.

### 3. Time for periodical service

– to avoid expensive repairs and unnecessary breakdowns. The STOP button [2] flashes and a message is shown in the display. Either "Time for service 1", "Time for service 2" or "Time for service 3" depending on which service is required. Sequence for service calls are: 1, 2, 1, 3, 1, 2, 1, 3... Phone number for Service company or Granuldisk is shown below the service message. The reminder can be reset by an authorised service technician, once the service is performed. OK is shown in the display during 2 seconds after the reset. Service message appears every 10.000 programs or once every 20 months, whichever occurs first.

#### Alarm priority

- "Change wash water" will always have first priority
- Once the water has been changed and the message is reset, the next message can be shown.
- Second priority "Change granules now", "Time for service" are alternately displayed, if issued at the same time.
- The reminders blink until messages are reset.



---

## 4 HACCP Hygiene and Operation Documentation

---

### 4.1 General

Granuldisk Documentation Tool, GDTdirect™, is an integrated function for the documentation of the pot washing machine's operating parameters and critical hygiene control points, HACCP. The following can be viewed:

- Operating data for the last 200 wash program run is viewed directly in the control panel window.
- Download of operating data for the last 200 wash program is available from USB Port. Also available in the exported report are dates for last service intervention and last Granule change (dates when the alarm was reset).
- Accumulated consumption of water and electricity since the start up of the machine.

## 4.2 Reading the data through the control panel

- 1 Press STOP button (2), release it and wait 3 seconds.
- 2 Press "Short program" (4), five times.
- 3 Use button "ECO program" (3) or button "Normal program (5) until you see "read operating data" in the display. Confirm your choice by pressing Confirm button (1).
- 4 Operating data for the last program run is shown in the display;

200121 15:19 SG 65/85 OK

The information is defined as follows:

- Date; 200121 2020, January, 21st
- Time; 15.19 3.19 p.m
- Program type; E, S, N equivalent to Eco, Short and Normal program
- Washing with granules; indicated by means of a "G", otherwise this box is left blank
- 65; indicates the average temperature in the wash tank during washing.
- 85; indicates the minimum temperature in the rinse tank during rinsing
- OK; indicates that you rinse with volume i.e. full volume (the programs that are preset for this are Short and Normal). "NA" (not applicable) will be shown if you rinse on time, i.e. not the entire volume (the programs that are preset for this are ECO and all COMBI/PLUS modes).



### **NOTE**

*If the wash program has been cancelled due to an operating error or technical error, the temperature indication is not included and "error" plus an error code appears in its place.*

200121 15:19 SG Error 103

- 5 To view information on program run previously, scroll backwards and forwards in the list using button "ECO program" (3) or button "Normal program" (5).
- 6 To end scrolling and leave the list, press Confirm button (1).
- 7 Press the STOP button (2) to return to operating mode.

## 4.3 Accumulated values for electricity and water consumption

- 1 Repeat steps 1-3 on previous page to enter user menu, but choose "Accumulated power and water" in step 3.
- 2 Accumulated values that are calculated from the operating data are shown. The values have an error margin of approximately 10%.
- 3 Values are presented e.g. as follows:

Accumulated kWh: 125  
Accumulated litres: 256

N.B. If the control board of the machine has been changed, the counter is reset.

## 4.4 Download of operation data from USB Port

- 1 Press STOP.
- 2 Insert a USB stick.

The USB port is found on the right side of the machine.

See Fig. 31 *USB port*



**Fig. 31 USB port**

- 3 Hold ECO and Normal program buttons in for 2 seconds.
- 4 After 10 seconds, function button lights up in green.
- 5 When green light goes out, the USB stick is ready to take out.
- 6 Make sure to close the protective cover cap by pressing it firmly after each use!

---

## 5 Trouble shooting and alerts

---

### 5.1 User related notices

- User related notices are codes 116, 118, 120, 124 and 132. They appear with a message in the display. Below table gives more details about the user related notices.
- When an alert is displayed, the program is always interrupted.
- After checking and taking care of the problem, the alert can be reset by pressing the STOP button.

<b>Error code</b>	<b>Meaning</b>	<b>Cause</b>	<b>Remedy</b>
<b>116</b>	Low water level, problem with foam.	Foam forming in the machine	Avoid using detergent designed for washing up by hand. Change the wash water. Contact the detergent supplier if the problems with foam formation still persist. Reset the alarm by pressing the STOP button.
<b>118</b>	Drain valve not closed	The drain valve has opened during an active process in the machine.	Close the drain valve and reset the alarm by pressing the STOP button.
<b>120</b>	Basket drive device blocked.	Something is preventing the rotation of the basket.	Check that nothing is stuck between the basket and the basket wheel. Reset the alarm by pressing the STOP button.

<b>Error code</b>	<b>Meaning</b>	<b>Cause</b>	<b>Remedy</b>
<b>124</b>	The crush protector has been activated	Something is preventing the hood's downward movement.	Remove whatever is obstructing the hood movement, reload the wash goods in the basket if necessary. Check the hood motion mechanics.
<b>132</b>	Clean level sensor	Level sensor is probably dirty or water is not exchanged after longer shut down period.	Lower the level and clean the level sensor in the wash tank. Refill the tank. If sensor is already cleaned, reset the error and set the machine in heating mode for continued heating

## 5.2 Error codes

The meaning of the error codes can be read out form the table below.

<b>Error code</b>	<b>Meaning</b>	<b>Cause</b>	<b>Remedy</b>
<b>001</b>		Program interrupted by operator.	This error code is displayed only when operating data is read.
<b>103</b>	Motor protector for rinse pump tripped.	The motor is overloaded, program is interrupted.	Contact a service engineer!
<b>104</b>	Overheating protector for rinse pump tripped, program is interrupted.	The rinse tank heater has overheated.	Clean level sensor. Reset overheat protection. If error code recurs in the next few hours, call a service engineer.
<b>105</b>	Overheating protector for wash tank tripped, program interrupted.	The wash tank heater has overheated.	Clean level sensor. Reset overheat protection. If error code recurs in the next few hours, call a service engineer.
<b>107</b>	Temperature not reached in wash tank	Temperature in wash tank not reached, program interrupted.	Reset the alarm by pressing the STOP button. If the alarm recurs, contact a service engineer.
<b>108</b>	Temperature not reached in rinse tank	Temperature in rinse tank not reached, on-going process interrupted.	Reset the alarm by pressing the STOP button. If the alarm recurs, contact a service engineer.
<b>110</b>	Temp sensor rinse tank not working.	The temperature sensor in the rinse tank is broken.	Contact a service engineer!
<b>111</b>	Temp sensor wash tank not working	The temperature sensor in the wash tank is broken	Contact a service engineer!

<b>Error code</b>	<b>Meaning</b>	<b>Cause</b>	<b>Remedy</b>
<b>112</b>	Water level too low in rinse tank.	The level in the rinse tank has fallen incorrectly.	Contact a service engineer!
<b>113</b>	Water level too low in wash tank.	The level in the wash tank has fallen incorrectly.	Contact a service engineer!
<b>114</b>	Long wash tank filling time.	Wash tank filling has exceeded its time limit.	Check the water supply to the machine, as well as the rinse pump. Clean the rinse nozzles. Reset the alarm by pressing the STOP button. If the alarm recurs, contact a service engineer.
<b>115</b>	Long rinse tank filling time	Rinse tank filling has exceeded its time limit.	Check the water supply to the machine, as well as the solenoid valve for rinse tank filling. Reset the alarm by pressing the STOP button. If the alarm recurs, contact a service engineer.
<b>117</b>	Long rinse time.	Too long rinse time. Correct water volume has not been reached in time.	Clean the rinse nozzles. Reset the alarm by pressing the STOP button. If the alarm recurs, contact a service engineer.
<b>119</b>	Motor protector, wash pump tripped .	The motor is overloaded, program is interrupted.	Contact a service engineer!
<b>121</b>	Motor protector, booster pump tripped.	The motor is overloaded.	Contact a service engineer!



<b>Error code</b>	<b>Meaning</b>	<b>Cause</b>	<b>Remedy</b>
<b>122</b>	Incorrect hood movement (closing).	Hood did not open on time. (Longer than 20 seconds)	Check the incoming water. Reset the alarm by pressing the STOP button. If the alarm recurs, contact service engineer.
<b>123</b>	Incorrect upwards movement of the hood	Hood did not open on time. (Longer than 20 seconds).	Check the incoming water. Reset the alarm by pressing the STOP button. If the alarm recurs, contact service engineer.
<b>125</b>	Incorrect hood movement, security switch.	The security switch has not signalled to the control unit within 5 seconds of the hood being raised from the tank.	Contact a service engineer!
<b>127</b>	Security switch is not working properly.	The safety switch is giving illogical signals.	Contact a service engineer!
<b>130</b>	IO board not tested at manufacture.	IO circuit board not tested at manufacture.	Contact a service engineer!
<b>133</b>	Short rinse time.	Rinse water was pumped out too fast, causing insufficient rinsing and heating of the wash ware.	Contact a service engineer!
<b>134</b>	Level detection function in the rinse tank is out of order.	False level signal from one of the level sensors in the rinse tank.	Turn the machine OFF! Continued operation can cause damage to other components. Contact a service engineer!

<b>Error code</b>	<b>Meaning</b>	<b>Cause</b>	<b>Remedy</b>
<b>143</b>	ID error.	Electrical error, identity outside range.	Contact a service engineer!
<b>144</b>	Wrong incoming voltage to IO circuit board.	Wrong incoming voltage to IO circuit board.	Continued operation can cause damage to the machine. Contact a service engineer.
<b>145</b>	Hood up switch broken.	Sensor system for hood not working.	Contact a service engineer!

---

## 6 Notes

---