

# Nor:disk Water-Smart technology - Installation requirements (mm)

## X2 Master & D2 Master Manual hood

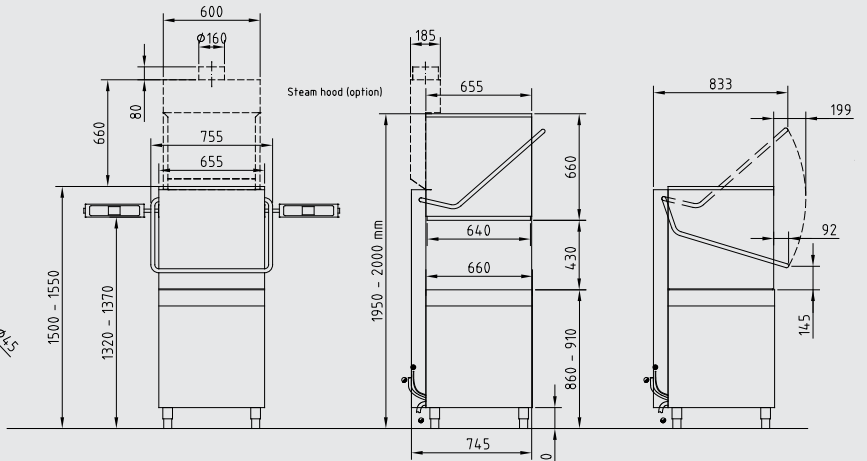

## X2 Master & D2 Master Kick'n Wash option

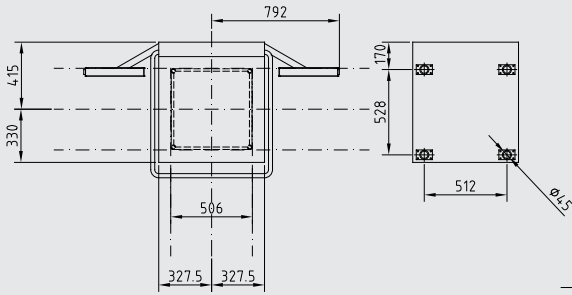
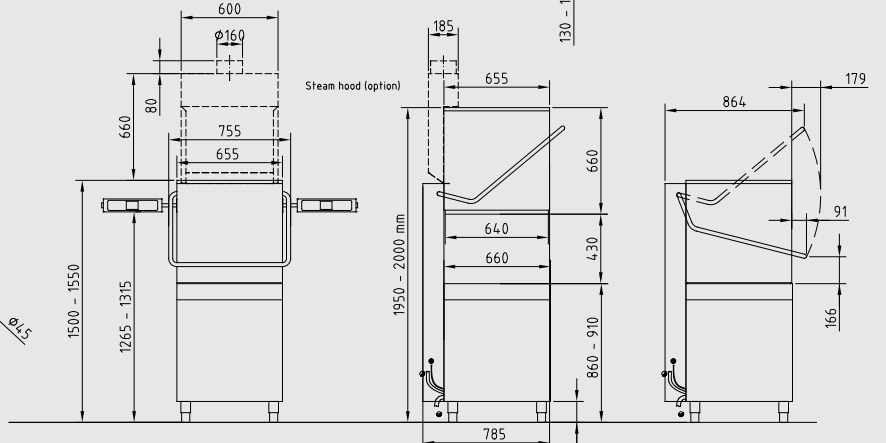
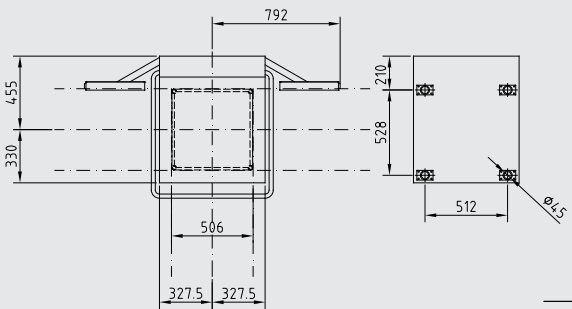

## X2 Master & D2 Master EcoExchanger® option

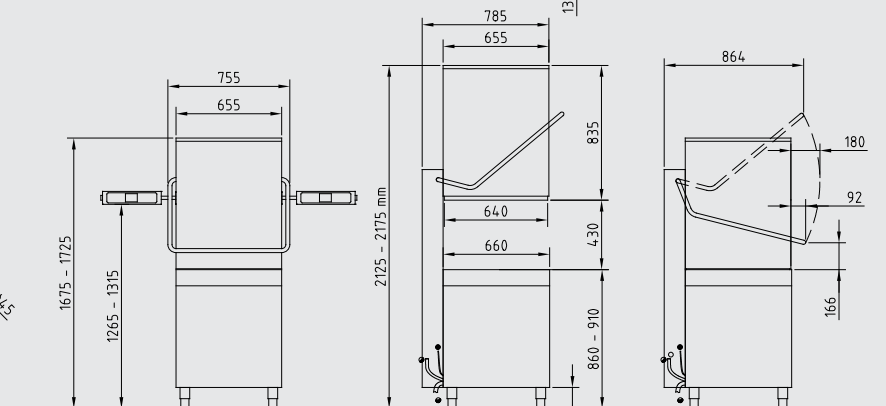
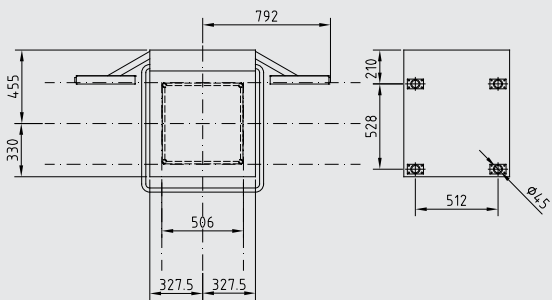

## D2 Base

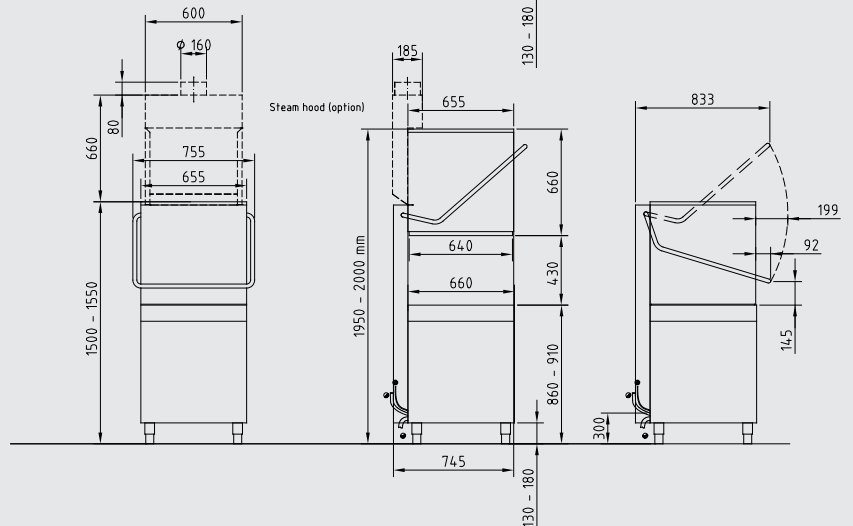
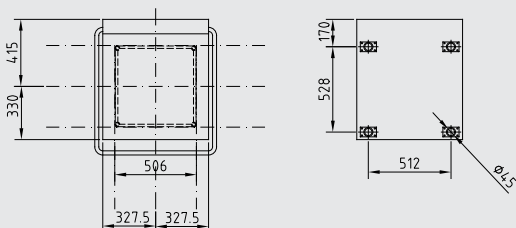

## X2 Master - D2 Master/D2 Base Labeling connections

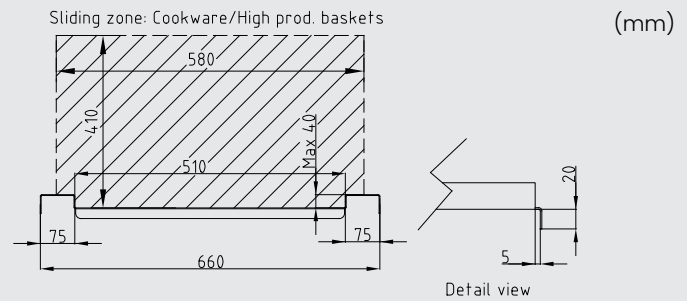

## X2 Master & D2 Master/D2 Base

	X2 Master		X2 Master	X2 Master with EcoExchanger
3N AC 380-415V 50Hz 3N AC 230V 50Hz option	16 A - 10 kW 32 A - 10 kW	Water inlet	55 °C - 2-5 bar <4 °dH/7 °fH - 3/4" fem.	55 °C and max. 25 °C - 2-5 bar <4 °dH/7 °fH - 3/4" fem.
Sound pressure level Operating weight	64 dB(A) Max. 227 kg	Drain	Ø 28 mm - 65 °C - 50 L/min.	
Norms compliance	CE - EN 17735:2023 EN 17735:2023 - IPX5 GS - RoHS - WEEE	Heat dissipation Tot./Sens./Lat.	5.8 kW / 2.1 kW / 3.7 kW	4.9 kW / 2.1 kW / 2.8 kW

	D2 Master & Base		D2 Master	D2 Base	D2 Master with EcoExchanger
3N AC 380-415V 50Hz 3N AC 230V 50Hz option 3N AC 380-415V 60Hz option	16 A - 7.1 kW 20 A - 7.1 kW 16 A - 7.1 kW	Water inlet	55 °C - 2-5 bar <4 °dH/7 °fH - 3/4" fem.		Max. 25 °C - 2-5 bar <4 °dH/7 °fH - 3/4" fem.
Sound pressure level Operating weight	59 dB(A) Max. 210 kg	Drain	Ø 28 mm - 65 °C - 50 L/min.		
Norms compliance	CE - EN 17735:2023 EN 17735:2023 - IPX5 GS - RoHS - WEEE	Heat dissipation Tot./Sens./Lat.	5.3 kW / 1.5 kW / 3.8 kW	4.8 kW / 1.6 kW / 3.2 kW	4.4 kW / 1.5 kW / 2.9 kW

## D1 Master & D1 Base

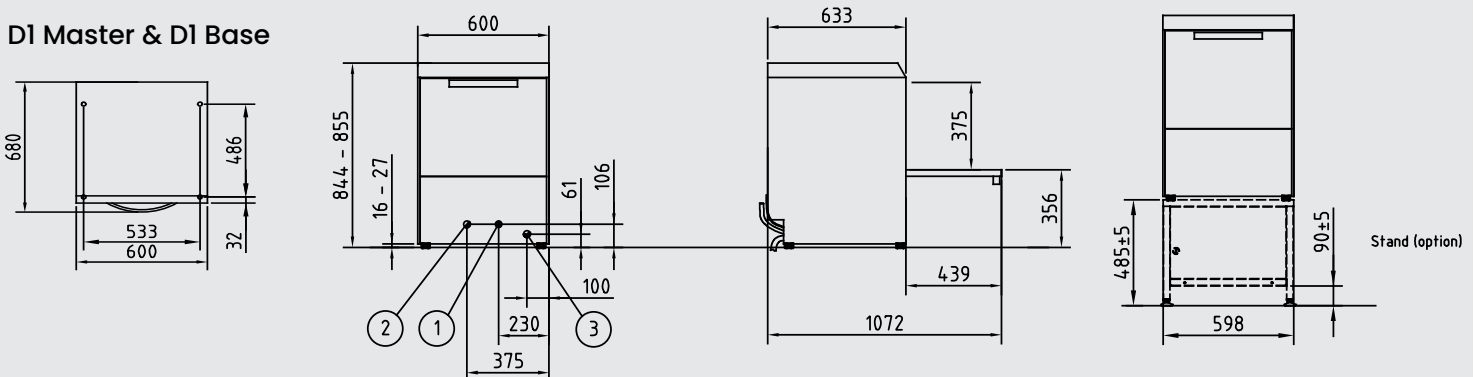

	D1 Master & Base		D1 Master	D1 Base	D1 Master with Water Softener
3N* AC 380-415V 50Hz 3N AC 230V 50Hz option 3N* AC 380-415V 60Hz option	① 10 A - 5.05 kW 16 A - 5.05 kW 10 A - 5.05 kW	Water inlet	② 55 °C - 2-5 bar <4 °dH/7 °fH - 3/4" fem.		② Max. 30 °C - 2-5 bar 3/4" fem.
Sound pressure level Operating weight	56 dB(A) Max. 98 kg	Drain	③	Ø 28 mm - 65 °C - 50 L/min.	
Norms compliance	CE - EN 17735:2023 - IPX5 GS - RoHS - WEEE	Heat dissipation Tot./Sens./Lat.	1.8 kW / 0.6 kW / 1.2 kW	1.6 kW / 0.7 kW / 0.9 kW	1.8 kW / 0.6 kW / 1.2 kW

\* Switchable to 1N AC 230V, 25A (5.05 kW) or to 1N AC 230V, 16A for D1 Master (3.5 kW).

## Non-electric hot or cold water softener - 8 kg salt

Power supply	None
Consumption regeneration	34 liters - 11 minutes
Water inlet	2-65 °C - 2-8.6 bar - 5-10 pH
Drain/Overflow	3/8" tube / 1/16" tube
Shipping/Operating weight	21 kg / 39 kg



**NOR:DISK**  
CLEAN SOLUTIONS

# Nor:disk Water-Smart technology - Installation requirements

(mm)

## X2 Master - D2 Master/D2 Base Labeling connections

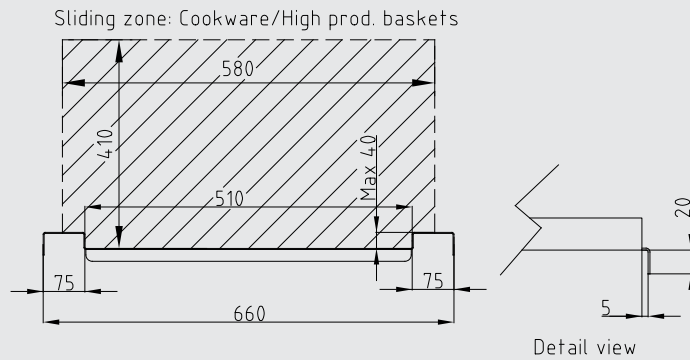

## Reversible inlet tables for X2 & D2 - Install right or left side

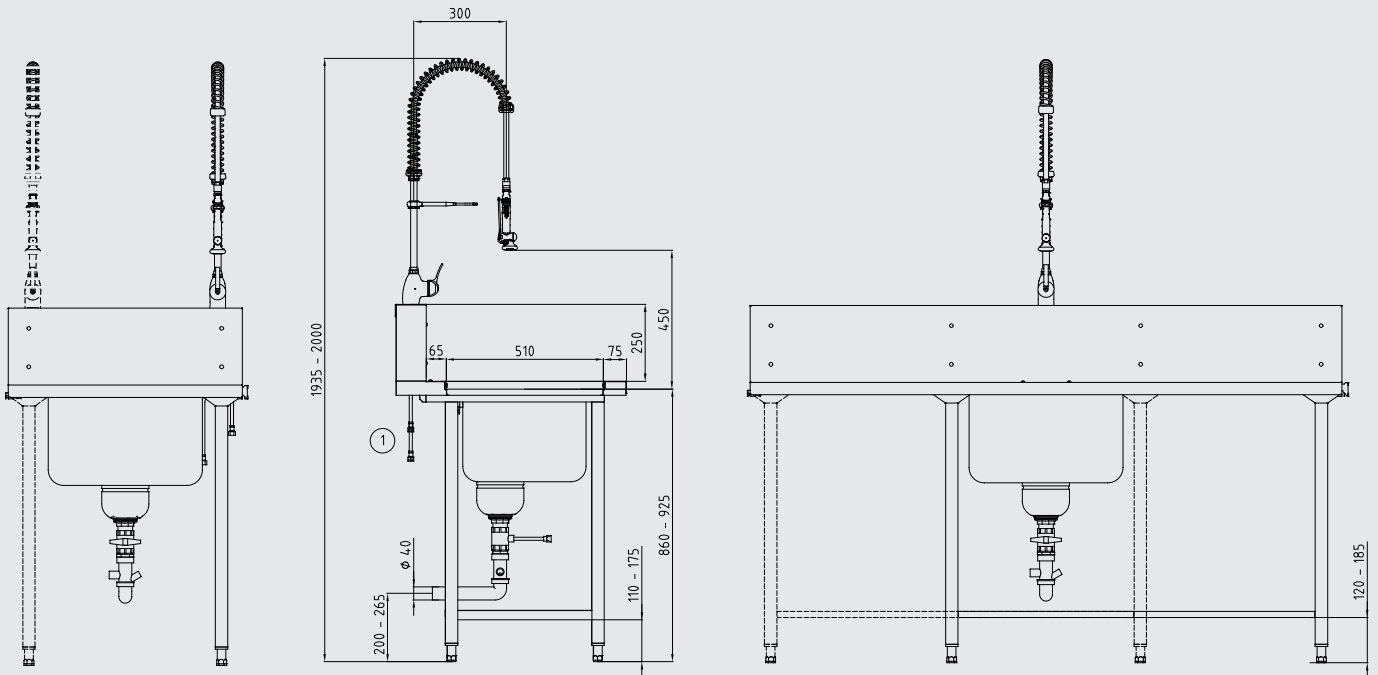
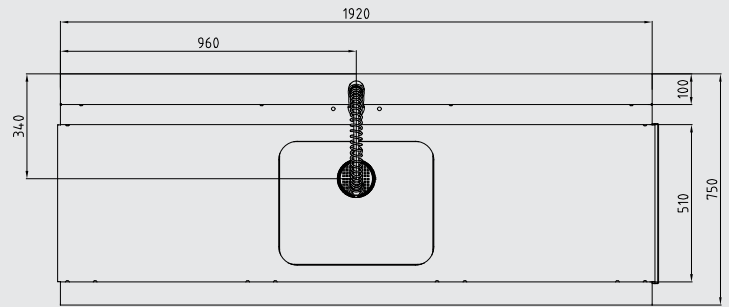
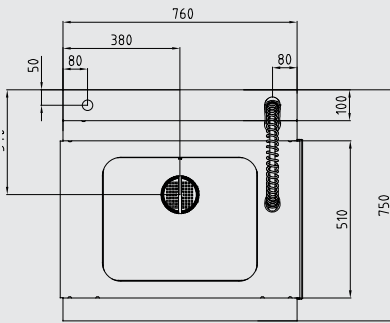

① 445-540 mm flexible stainless steel supply hoses with check valves and female G3/8" inlet.

# Nor:disk Water-Smart technology - Installation requirements

(mm)

## Reversible outlet tables for X2 & D2 - Install right, left or front side

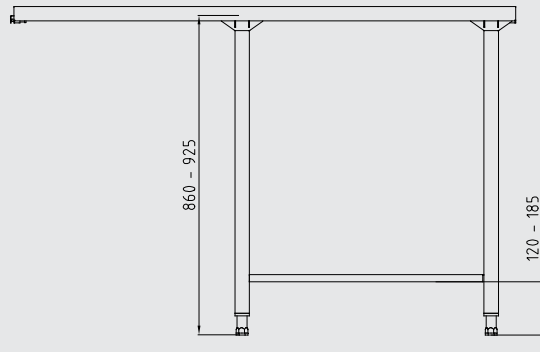
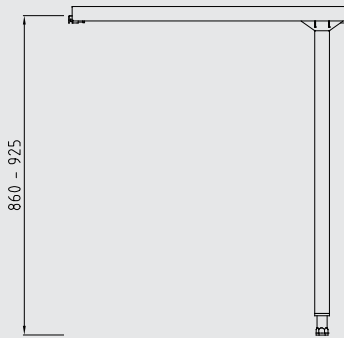
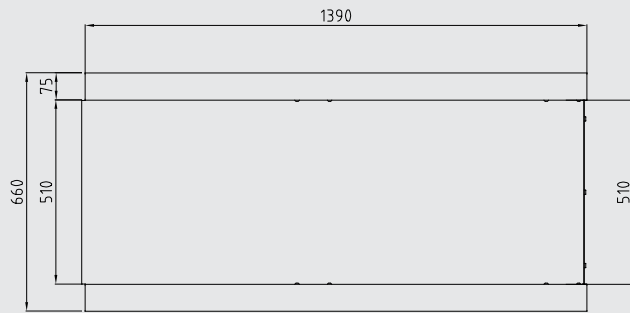
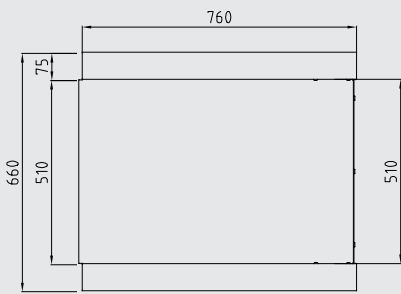

## Bridge table - install between two X2 and/or D2

